



Bezeichnung: Attika-Super-Gully mit Keil aus PUR DN 100

Artikel-Nr.: 110.350.014

Zeichn.-Nr.:

Stand: 05.03.2018

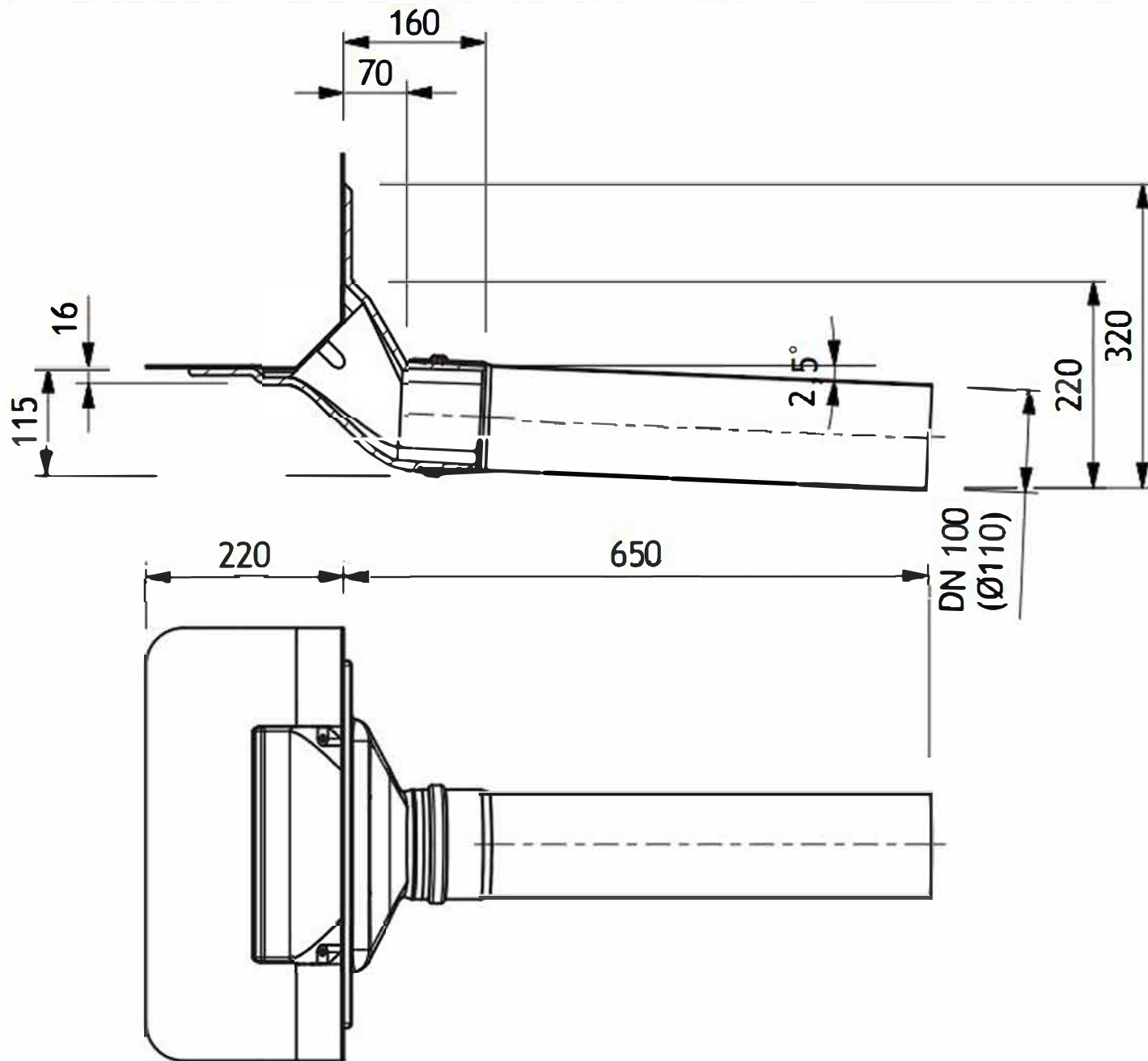
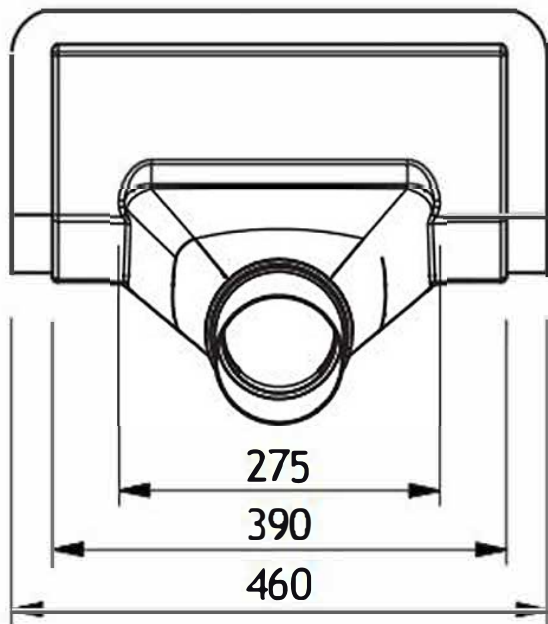

IBL Baustoff+Labor GmbH

Theillissengasse 3
A-2201 Gerasdorf bei Wien
Tel: +43(0)2246 - 20 500
Fax: +43(0)2246 - 20 500 / 20
ibl@ibl.at www.ibl.at